



**FEATURES**

- Low leakage current, long life
- High power, high energy density
- Small size and low-resistance
- Long cycle life, maintenance-free
- REACH, RoHS Directive Compliant

**APPLICATIONS**

• Consumer electronics, GSM/GPRS Pulse applications, Backup power, Stand alone or augment existing, energy/power source.

**OPERATING TEMPERATURE RANGE**

- -40°C to +70°C @2.7V
- -40°C to +85°C @2.3V



**GENERAL SPECIFICATIONS**

Item	Performance
Operating temperature	-40°C to +70°C
Capacitance range	0.15F to 120F
Rated voltage	2.7 V
Surge voltage	2.85 V
Temperature characteristics	Capacitance change: Within ±30% of initial measured value at +25°C Internal resistance: Within ±200% of initial measured value at +25°C
High temperature load time	After 70°C 1500 hours : Capacitance change: ±30% of initial rated value Internal resistance: Within 2 times of initial specified value
Projected cycle life (From rated voltage to 1/2 rated voltage at 25°C)	After 500,000 cycles: Capacitance change: Within ±30 % of initial rated value Internal resistance: Within 2 times of initial specified value
Humidity characteristic	Relative humidity: 90%~95% /Duration of testing:240 hrs /Temperature:40±2°C Capacitance change: Within ±30 % of initial rated value Internal resistance: Within 2 times of initial specified value
Vibration resistance	Amplitude:1.5mm /Frequency:10~55Hz /Duration: X,Y,Z(2 hrs)/Duration of testing:6 hrs Capacitance change: Within ±30 % of initial rated value Internal resistance: Within 2 times of initial specified value
Shelf life	After 2 years at 25°C without load, the capacitor shall meet the specified endurance limits.

**PART NUMBER SYSTEM**

<u>CXHP</u>	<u>2R7</u>	<u>105</u>	<u>R</u>	<u>TW</u>	<u>*</u> <u>-</u>	<u>***</u> <u>—</u>
Series	Rated Voltage	Capacity Code	Environmental Code	MFG Code	Special Code	Custom Code

**Casing Display:**

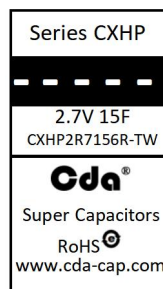

DIMENSIONS



RADIAL LEAD TYPE

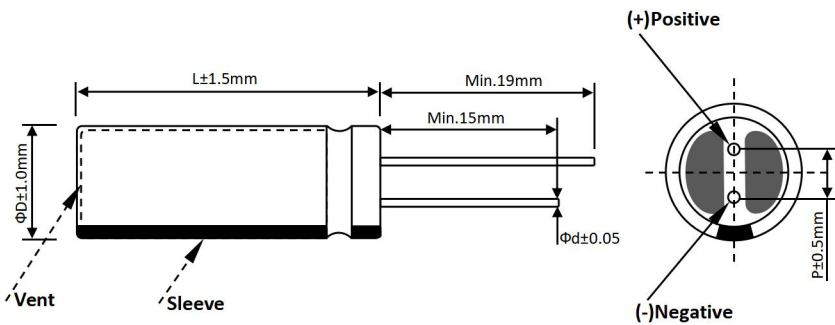

Size(mm)		
ΦD	P	Φd
4	1.5	0.5
5	2.0	0.5
6.3	2.5	0.6
8	3.5	0.6
10	5.0	0.6
12.5	5.0	0.6
16	7.5	0.8
18	7.5	0.8

RADIAL BENT LEAD TYPE

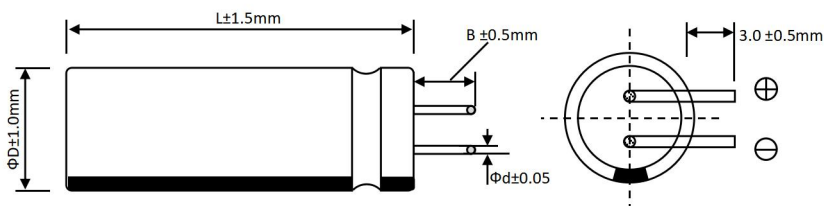

Style	B(mm)
A1	4.0
C1	2.0

STANDARD PRODUCTS

Part Number	Working Voltage (V DC)	Rated Cap. (F)	Capacitance Tolerance	Dimensions (mm)		Max.ESR		Maximum Leakage (72hrs/mA)	Maximum Peak Current(A)	Maximum Endurance Current(A)	Power Density (W/Kg)	Maximum Energy (W.h)	Energy Density (Wh/kg)
				D	L	ESRAC (1kHz/mΩ)	ESRDC (mΩ)						
<b>Radial Lead(Miniaturized)</b>													
*CXHP2R7154R-TW	2.7	0.15	-0%~+100%	4	10	1000	1820	0.001	0.17	0.09	833	0.00015	0.38
*CXHP2R7224R-TW	2.7	0.22	-0%~+100%	4	10	1000	1820	0.001	0.17	0.09	833	0.0002	0.38
*CXHP2R7224R-TWX	2.7	0.22	-0%~+100%	5	10	700	1200	0.002	0.19	0.10	1135	0.0002	0.34
*CXHP2R7304R-TW	2.7	0.3	-0%~+100%	4	10	700	1200	0.002	0.19	0.11	1249	0.0003	0.38
*CXHP2R7354R-TW	2.7	0.35	-0%~+100%	5	10	600	1000	0.002	0.40	0.15	1055	0.0003	0.87
*CXHP2R7504R-TWX	2.7	0.5	-0%~+100%	5	12	600	1000	0.003	0.45	0.15	1077	0.0005	1.02
CXHP2R7504R-TW	2.7	0.5	-0%~+100%	6.3	12	240	1600	0.006	0.52	0.14	1003	0.0005	1.86
*CXHP2R7604R-TW	2.7	0.6	-0%~+100%	4	22	700	1200	0.003	0.45	0.16	1093	0.0006	1.42
*CXHP2R7105R-TWV	2.7	1	-0%~+100%	4	25	550	900	0.003	0.54	0.18	1023	0.0010	1.78
CXHP2R7105R-TWX	2.7	1	-0%~+100%	6.3	12	300	1500	0.006	0.54	0.16	1377	0.0012	1.92
CXHP2R7125R-TWX	2.7	1.2	-0%~+100%	6.3	11	200	400	0.003	0.66	0.18	3645	0.0012	1.62
*CXHP2R7125R-TW	2.7	1.2	-0%~+100%	5	22	200	400	0.006	1.16	0.33	2499	0.0012	2.17
*CXHP2R7255R-TW	2.7	2.5	-0%~+100%	5	22	200	400	0.006	1.50	0.33	2499	0.0025	3.62
CXHP2R7335R-TWX	2.7	3.3	-0%~+100%	6.3	22	90	180	0.010	2.44	0.53	3332	0.0033	3.18
CXHP2R7405R-TWV	2.7	4	-0%~+100%	6.3	25	90	130	0.010	2.44	0.53	3332	0.0040	3.18

For product specifications of '\*', please contact CDA or agents before purchase

## STANDARD PRODUCTS



Part Number	Working Voltage (V DC)	Rated Cap. (F)	Capacitance Tolerance	Dimensions (mm)		Max.ESR		Maximum Leakage (72hrs/mA)	Maximum Peak Current(A)	Maximum Endurance Current(A)	Power Density (W/Kg)	Maximum Energy (W.h)	Energy Density (Wh/kg)
				D	L	ESRAC (1kHz/mΩ)	ESRDC (mΩ)						
<b>Radial Lead</b>													
CXHP2R7105R- TW	2.7	1	-20%~+50%	8	12	160	240	0.006	1.09	0.47	4050	0.0010	1.13
CXHP2R7205R-TWX	2.7	2	-20%~+50%	8	16	120	180	0.010	1.99	0.61	4459	0.0020	1.86
CXHP2R7205R- TW	2.7	2	-20%~+50%	8	12	100	280	0.010	1.73	0.49	2924	0.0020	1.90
CXHP2R7205R- TWQ	2.7	2	-20%~+50%	8	20	100	120	0.012	2.15	0.55	2924	0.0020	2.15
CXHP2R7255R- TWX	2.7	2.5	-20%~+50%	8	16	130	180	0.025	2.27	0.59	4115	0.0025	2.32
CXHP2R7305R- TWX	2.7	3	-20%~+50%	8	16	130	195	0.012	2.56	0.59	4116	0.0030	2.79
CXHP2R7305R- TW	2.7	3	-20%~+50%	8	20	100	120	0.012	2.79	0.65	4486	0.0030	2.34
CXHP2R7335R- TW	2.7	3.3	-20%~+50%	8	20	100	150	0.012	2.98	0.74	4486	0.0033	2.57
CXHP2R7405R- TW	2.7	4	-20%~+50%	10	20	70	170	0.015	3.65	0.79	2339	0.0040	2.40
CXHP2R7475R- TW	2.7	4.7	-20%~+50%	10	20	72	170	0.017	3.60	0.75	2340	0.0047	2.50
CXHP2R7505R-TWX	2.7	5	-20%~+50%	8	25	90	135	0.015	4.03	0.87	3857	0.0051	3.01
CXHP2R7505R-TWV	2.7	5	-20%~+50%	8	20	110	150	0.015	3.70	0.71	3534	0.0051	3.38
CXHP2R7505R-TWQ	2.7	5	-20%~+50%	10	16	90	135	0.020	4.03	0.80	3240	0.0051	2.53
CXHP2R7505R- TW	2.7	5	-20%~+50%	10	20	75	113	0.015	4.32	0.97	3535	0.0051	2.30
CXHP2R7605R- TW	2.7	6	-20%~+50%	10	20	75	113	0.020	5.20	0.97	3518	0.0061	2.77
CXHP2R7705R- TW	2.7	7	-20%~+50%	10	20	75	113	0.020	5.29	0.97	3535	0.0071	3.22
CXHP2R7705R- TWX	2.7	7	-20%~+50%	8	25	90	135	0.015	4.86	0.87	3600	0.0071	3.94
CXHP2R7705R-TWQ	2.7	7	-20%~+50%	8	30	60	120	0.028	6.84	1.43	3600	0.0071	4.80
CXHP2R7805R- TW	2.7	8	-20%~+50%	10	25	60	150	0.020	4.61	0.93	2303	0.0081	2.80
CXHP2R7805R- TWX	2.7	8	-20%~+50%	12.5	20	60	150	0.020	7.58	1.35	3557	0.0081	2.94
CXHP2R7106R-TWV	2.7	10	-20%~+50%	8	30	60	120	0.028	7.11	1.61	4606	0.0101	4.80
CXHP2R7106R- TW	2.7	10	-20%~+50%	10	25	65	98	0.030	6.84	1.15	3451	0.0101	3.89
CXHP2R7106R- TWQ	2.7	10	-20%~+50%	10	30	50	75	0.030	7.71	1.43	3800	0.0101	3.30
CXHP2R7106R-TWX	2.7	10	-20%~+50%	12.5	20	45	68	0.030	8.06	1.42	3757	0.0101	2.94
CXHP2R7116R-TW	2.7	11	-20%~+20%	10	30	45	68	0.030	8.06	1.51	4114	0.0110	3.21
CXHP2R7126R- TW	2.7	12	-20%~+20%	12.5	20	50	75	0.036	8.53	1.35	3381	0.0122	3.52
CXHP2R7136R-TW	2.7	13	-20%~+20%	10	25	40	90	0.020	8.60	1.27	3770	0.0132	4.54
CXHP2R7156R- TW	2.7	15	-20%~+20%	12.5	25	40	60	0.050	10.66	1.80	3359	0.0152	3.50
CXHP2R7156R- TWX	2.7	15	-20%~+20%	12.5	20	45	68	0.040	10.06	1.42	3550	0.0152	4.16
CXHP2R7186R- TW	2.7	18	-20%~+20%	12.5	25	40	60	0.055	12.27	1.66	3645	0.0183	5.06
CXHP2R7206R- TW	2.7	20	-20%~+20%	12.5	25	30	60	0.060	13.50	2.70	2692	0.0203	3.10
CXHP2R7206R- TWQ	2.7	20	-20%~+20%	12.5	30	35	53	0.055	13.17	1.93	3920	0.0203	4.76
CXHP2R7226R- TWV	2.7	22	-20%~+20%	12.5	35	30	45	0.056	11.33	1.93	3535	0.0223	3.68
CXHP2R7256R- TW	2.7	25	-20%~+20%	16	25	27	50	0.060	15.00	2.09	2419	0.0253	3.50
CXHP2R7256R- TWV	2.7	25	-20%~+20%	12.5	35	30	45	0.060	15.88	2.23	3534	0.0253	4.60
CXHP2R7306R- TW	2.7	30	-20%~+20%	16	30	20	40	0.070	18.41	2.53	2664	0.0304	3.70
CXHP2R7306R- TWX	2.7	30	-20%~+20%	16	25	25	38	0.072	19.06	2.41	3049	0.0304	3.97
CXHP2R7356R-TWX	2.7	35	-20%~+20%	16	30	22	33	0.080	21.93	2.79	3194	0.0354	4.27
CXHP2R7356R-TW	2.7	35	-20%~+20%	16	35	19	42	0.086	23.86	3.24	3220	0.0354	3.65
CXHP2R7346R-TW	2.7	34	-20%~+20%	12.5	46	20	45	0.080	23.68	3.01	3694	0.0344	5.47
CXHP2R7406R-TWX	2.7	40	-20%~+20%	12.5	46	20	45	0.080	23.68	3.01	3694	0.0405	5.47
CXHP2R7506R- TW	2.7	50	-20%~+20%	18	40	16	24	0.105	30.68	3.96	2848	0.0506	3.96
CXHP2R7506R- TWQ	2.7	50	-20%~+20%	12.5	50	18	35	0.105	28.72	3.40	3640	0.0506	5.69
CXHP2R7506R- TWX	2.7	50	-20%~+20%	18	35	18	27	0.110	30.92	3.52	2700	0.0506	5.06
CXHP2R7606R- TW	2.7	60	-20%~+20%	18	40	15	23	0.150	34.47	4.09	2880	0.0608	4.28
CXHP2R7706R- TW	2.7	70	-20%~+20%	18	40	15	22	0.125	36.21	4.05	3042	0.0709	5.67
CXHP2R7826R- TW	2.7	82	-20%~+20%	18	40	15	22	0.140	38.03	4.05	2817	0.0810	6.00
CXHP2R7107R-TWV	2.7	100	-20%~+20%	18	60	13	20	0.240	45.76	5.30	2136	0.1013	4.82
CXHP2R7127R- TWV	2.7	120	-20%~+20%	18	60	13	20	0.280	48.50	5.30	2039	0.1215	5.52

\*operating temperature can be extended to 85°C with appropriate voltage

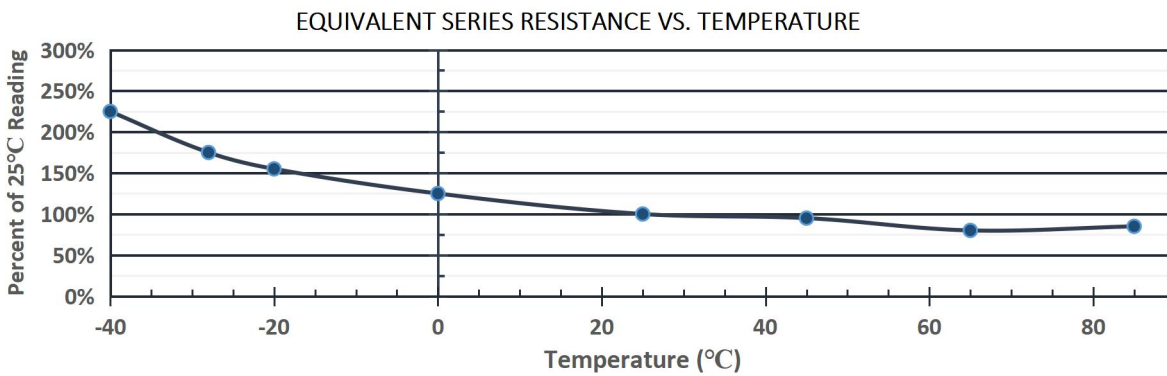
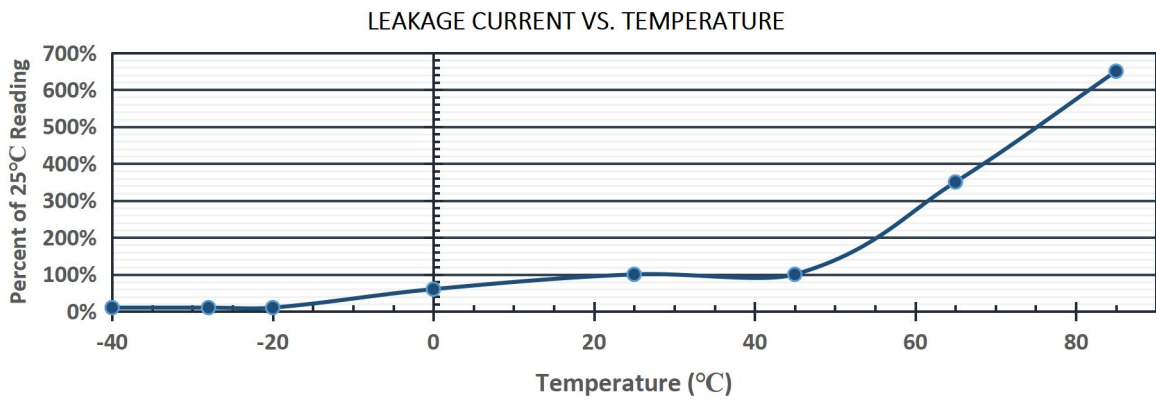
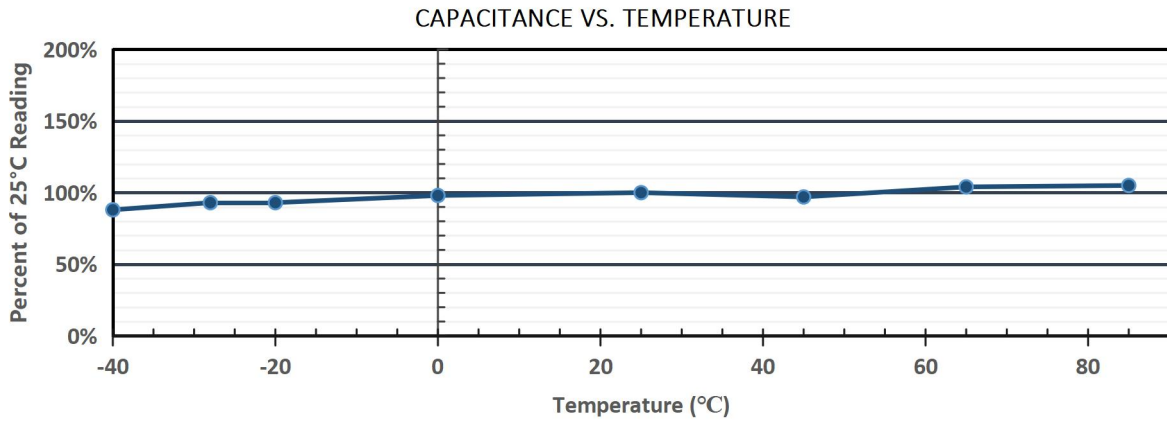



**LIFE TIME AND TEMPERATURE PERFORMANCE**

The life of a Super Capacitor is impacted by a combination of operating voltage and the operating temperature according to the following equation :

$$L = L_0 \times 3.25^{\frac{T_0 - T}{10}} \times 1.52^{\frac{V_0 - V}{0.1}}$$

**L** : is the theoretical lifetime at T temperature;

**L<sub>0</sub>** : is the working life of the highest rated working temperature;

**T** : is the actual working temperature;

**T<sub>0</sub>** : is the highest rated working temperature;

**V** : is the actual working voltage;

**V<sub>0</sub>** : is the highest rated working voltage.

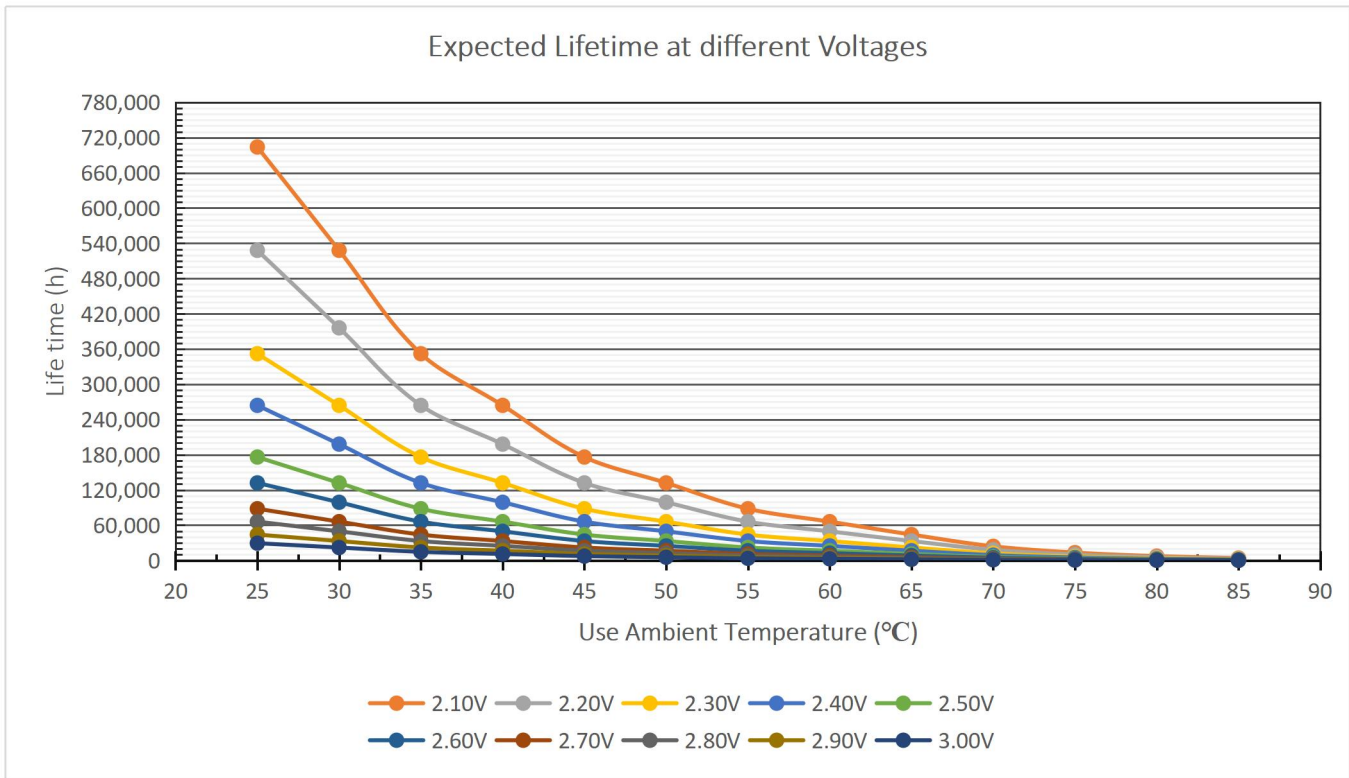

\*Note : Estimated lifespan: The estimated lifespan under different operating voltages and operating temperatures in a theoretical environment. For the actual service life, please contact us to discuss the working conditions.



## SAFETY RECOMMENDATIONS

### WARNINGS

- To Avoid Short Circuit, after usage or test, SuperCapacitors voltage needs to discharge to  $\leq 0.1V$  .
- Do not Apply Over-voltage, Reverse Charge, Burn or Heat Higher than  $150^{\circ}C$ , explosion-proof valve may break open .
- Do not Press, Damage or disassemble the SuperCapacitor, housing could heat to high temperature causing Burns.
- If you observe Overheating or Burning Smell from the capacitor disconnect Power immediately, and do not touch.

## PRECAUTIONS FOR WELDING

When soldering supercapacitors to a PCB, the temperature & time that the body of the supercapacitor sees during soldering can have a negative effect on performance. We advise following these guidelines:

- Do not immerse the supercapacitors in solder. Only the leads should come in contact with the solder.
- Ensure that the body of the supercapacitor is never in contact with the molten solder, the PCB or other components during soldering.
- Excessive temperatures or excessive temperature cycling during soldering may cause the safety vent to burst or the case to shrink or crack, potentially damaging the PCB or other components, and significantly reduce the life of the capacitor.

### HAND SOLDERING

Keep distance between the supercapacitor body and the tip of the soldering iron and the tip should never touch the body of the capacitor. Contact between supercapacitor body and soldering iron will cause extensive damage to the supercapacitor, and change its electrical properties. It is recommended that the soldering iron temperature should be less than  $350^{\circ}C$ , and contact time should be limited to less than 4 seconds. Too much exposure to terminal heat during soldering can cause heat to transfer to the body of the supercapacitor, potentially damaging the electrical properties of the supercapacitor.

### REGULATORY

- MSDS
- RoHS Compliant
- Reach Compliant

### TRANSPORTATION

Not subjected to US DOT or IATA regulations  
 UN3499, <10Wh, Non-Hazardous Goods  
 International shipping description –  
 “Electronic Products – Capacitor”

### WAVE SOLDERING

Only use wave soldering on Radial type supercapacitors. The PCB should be preheated only from the bottom and for less than 60 seconds, with temperature at, or below,  $100^{\circ}C$  on the top side of the board for PCBs equal to or greater than 0.8 mm thick.

Solder Temperature ( $^{\circ}C$ )	Suggested Solder Time (s)	Maximum Solder Time (s)
220	7	9
240	7	9
250	5	7
260	3	5

### REFLOW SOLDERING

Infrared or conveyor over reflow techniques can be used on these supercapacitors. Do not use a traditional reflow oven without clear rated reflow temperature for supercapacitors.